



**ProLight PBLB-1CQA-TCL**  
**1W UV Power LED**  
**Technical Datasheet**  
**Version: 1.2**

# ProLight Opto <sup>®</sup> PBLB Series

## Features

- Best thermal material solution of the world
- RoHS compliant
- View angle 120°
- UVA+UVC dual wavelength design.
- Inside

## Main Applications

- Disinfection, Sterilization
- Phototherapy
- Fluorescent spectroscopy
- Dotection

## Emitter Mechanical Dimensions

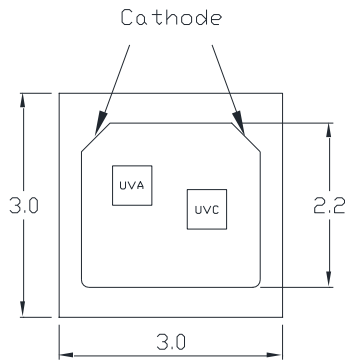

Top View

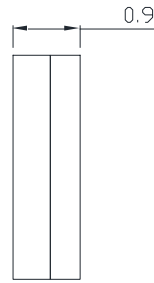

Side View

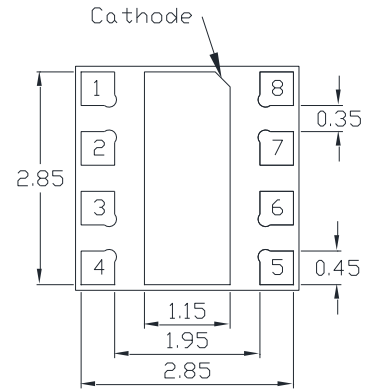

Bottom View

### Circuit Diagram

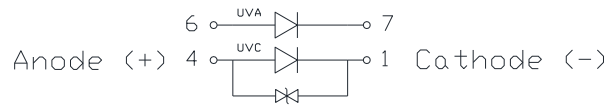

### Notes:

1. The cathode side of the device is denoted by the chamfer on the part body.
  2. Electrical insulation between the case and the board is required. Do not electrically connect either the anode or cathode to the slug.
  3. Drawing not to scale.
  4. All dimensions are in millimeters.
  5. Unless otherwise indicated, tolerances are  $\pm 0.10\text{mm}$ .
  6. Please do not solder the emitter by manual hand soldering, otherwise it will damage the emitter.
  7. The UV LED is not protected by a lens and requires careful handling
    - (1) Do not handle the LED with bare hands as it may contaminate the LED surface and affect the optical characteristics.
    - (2) Avoid touching the LED die
- \*The appearance and specifications of the product may be modified for improvement without notice.

## Flux Characteristics, $T_j = 25^\circ\text{C}$

Radiation Pattern	Color	Part Number Emitter	Test Current (mA)	Radiometric Power (mW)		Refer Test Current (mA)	Refer Radiometric Power (mW) Typ.
				Min.	Typ.		
Lambertian	UVC	PBLB-1CQA-TCL	20	1.5	2.5	70	7.5
	UVA		20	10	13	40	40

- ProLight maintains a tolerance of  $\pm 10\%$  on flux and power measurements.
- Please do not drive at rated current more than 1 second without proper heat sink.

## Electrical Characteristics, $T_j = 25^\circ\text{C}$

Color	Test Current (mA)	Forward Voltage $V_F$ (V)			Thermal Resistance Junction to Slug ( $^\circ\text{C}/\text{W}$ )
		Min.	Typ.	Max.	
UVC	20	5.0	6.8	8.0	15
UVA	20	3.0	3.2	3.4	15

- ProLight maintains a tolerance of  $\pm 0.1\text{V}$  for Voltage measurements.

## Optical Characteristics, $T_j = 25^\circ\text{C}$

Radiation Pattern	Color	Test Current (mA)	Peak Wavelength $\lambda_P$			Total included Angle (degrees) $\theta_{0.90V}$	Viewing Angle (degrees) $2\theta_{1/2}$
			Min.	Typ.	Max.		
Lambertian	UVC	20	265 nm	275 nm	280 nm	160	120
	UVA	20	400 nm	405 nm	410 nm	160	120

- ProLight maintains a tolerance of  $\pm 3\text{nm}$  for dominant wavelength measurements.

## Absolute Maximum Ratings

Parameter	UVC	UVA
DC Forward Current (mA)	70	40
Peak Pulsed Current (mA)	100	100
ESD Sensitivity (HBM per MIL-STD-883E Method 3015.7)	±4000V	±500V
LED Junction Temperature	80°C	
Operating Board Temperature at Maximum DC Forward Current	-40°C - 60°C	
Storage Temperature	-40°C - 85°C	
Soldering Temperature	JEDEC-J-STD-020D	
Allowable Reflow Cycles	3	
Reverse Voltage	Not designed to be driven in reverse bias	

## Peak Wavelength Bin Structure

Color	Bin Code	Minimum Peak Wavelength (nm)	Maximum Peak Wavelength (nm)
UVC	A	265	270
	B	270	275
	C	275	280
UVA	0	400	410

- ProLight maintains a tolerance of  $\pm 3\text{nm}$  for peak wavelength measurements.

## Forward Voltage Bin Structure

Color	Bin Code	Minimum Voltage (V)	Maximum Voltage (V)
UVC	A	5.0	5.5
	B	5.5	6.0
	C	6.0	6.5
	D	6.5	7.0
	E	7.0	7.5
	F	7.5	8.0

- ProLight maintains a tolerance of  $\pm 0.1\text{V}$  for Voltage measurements.

Note: Although several bins are outlined, product availability in a particular bin varies by production run and by product performance. Not all bins are available in all colors.

## Color Spectrum, $T_j = 25^\circ\text{C}$

### 1. UVC, UVA

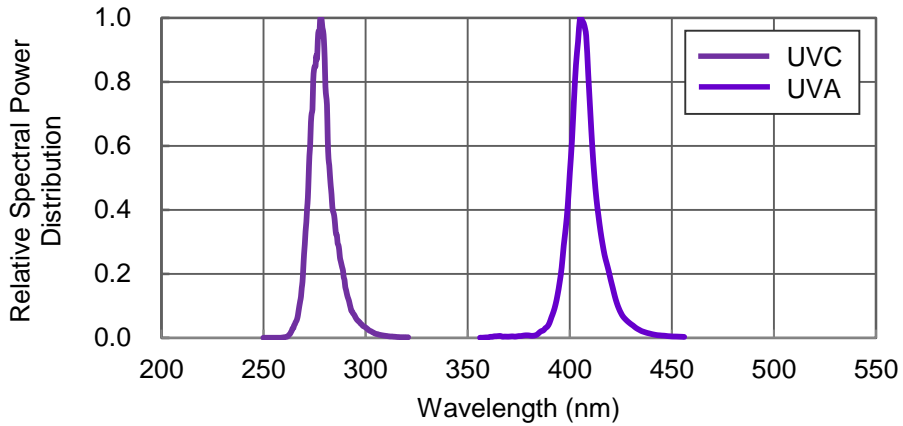

## Forward Current Characteristics, $T_j = 25^\circ\text{C}$

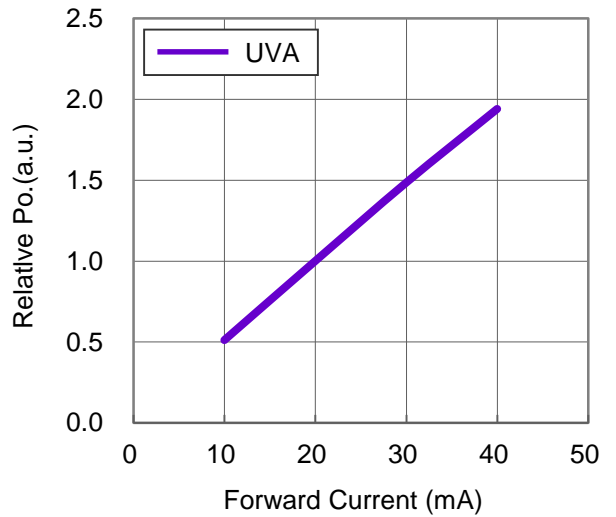
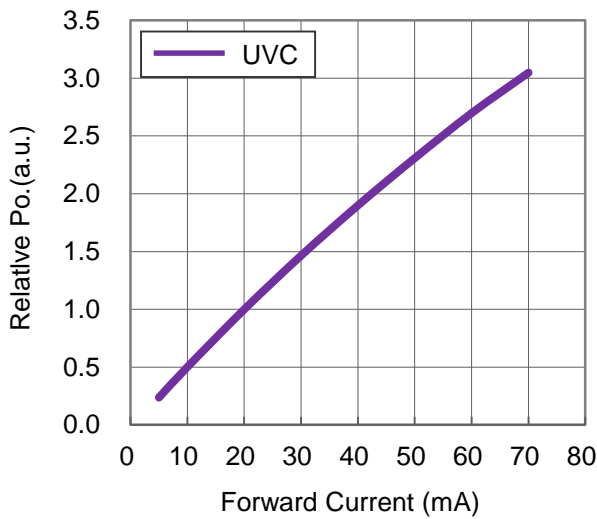
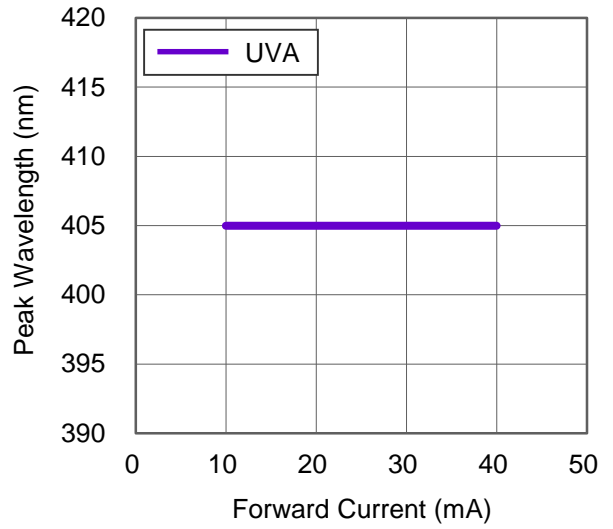
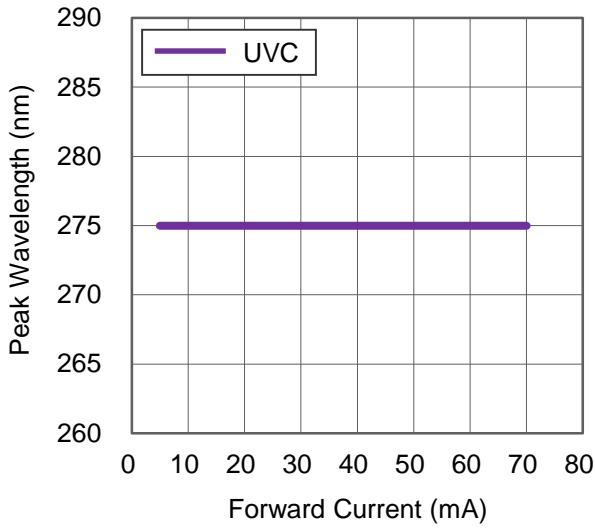

## Forward Current Characteristics, $T_j = 25^\circ\text{C}$

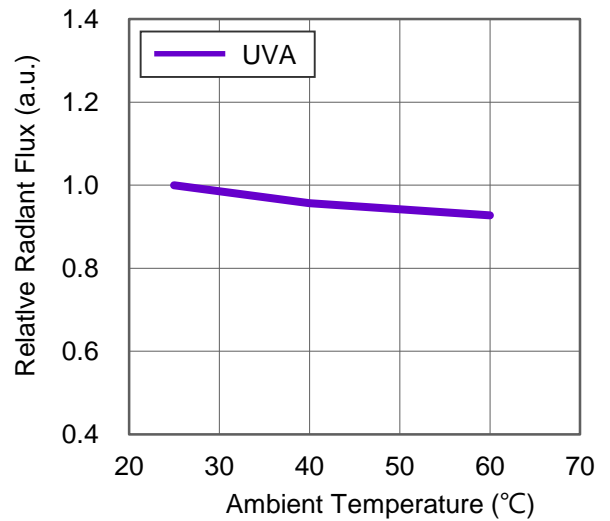
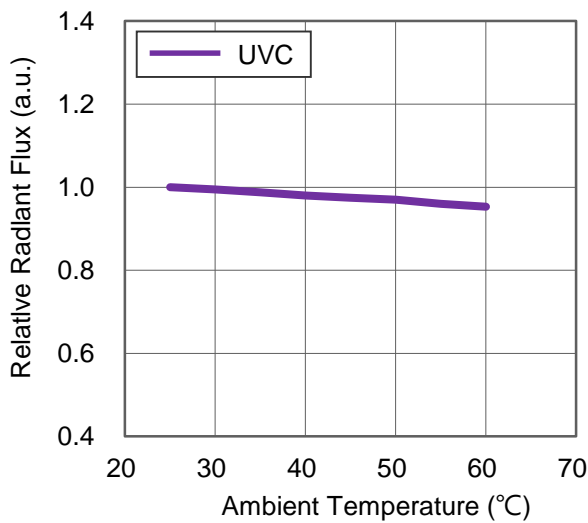
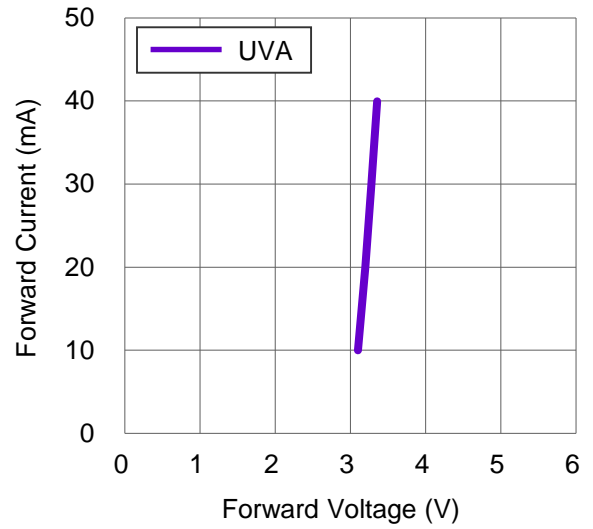
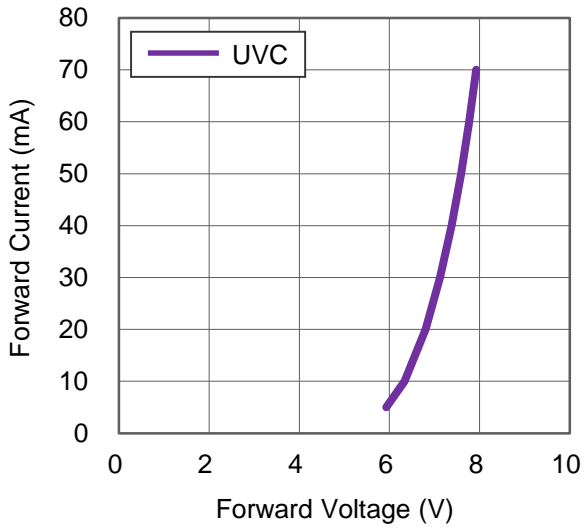

## Forward Current Characteristics, $T_j = 25^\circ\text{C}$

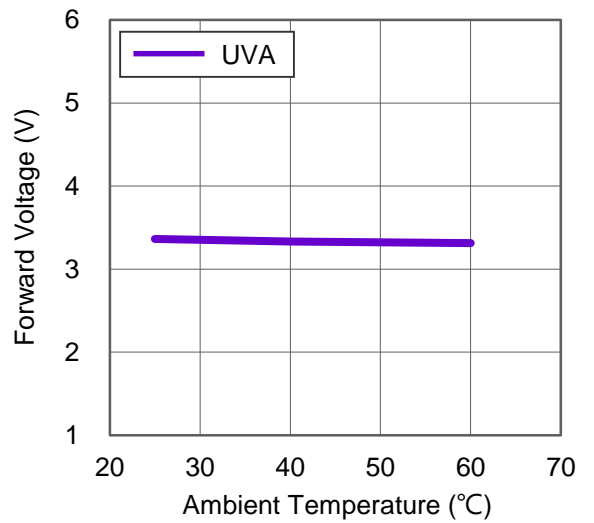
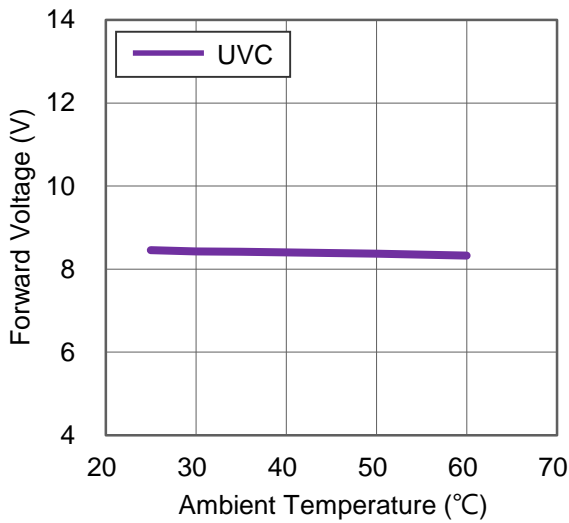
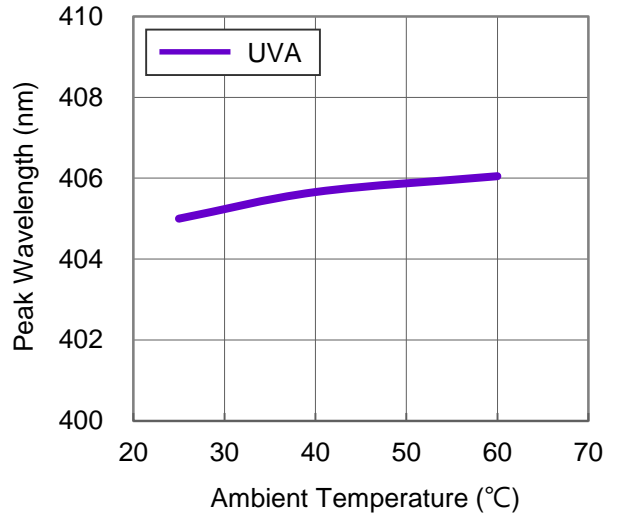
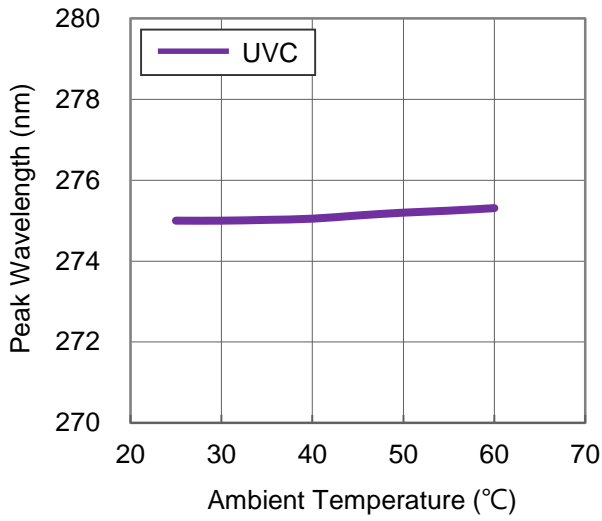



# Solder Temperature (Slug) vs. Maximum Forward Current

## 1. UVC ( $T_{JMAX} = 85^{\circ}C$ )

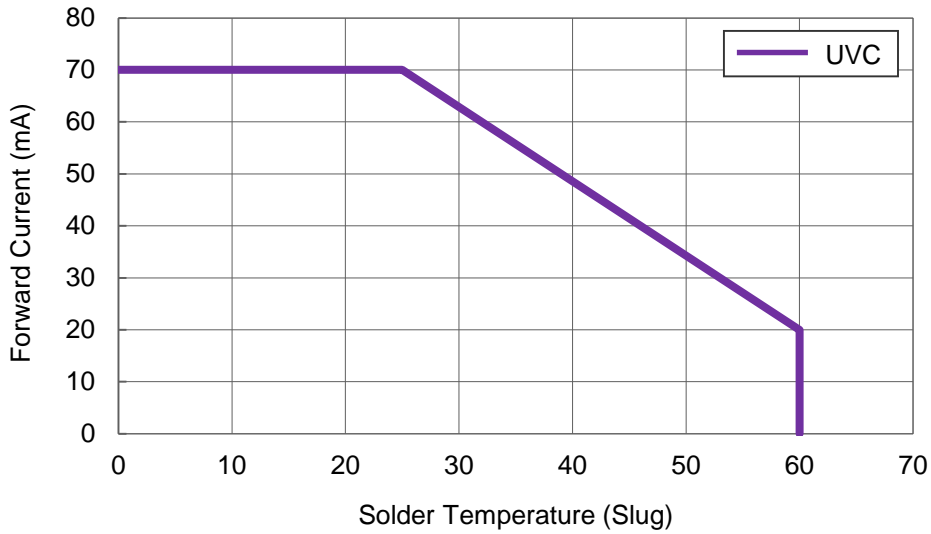

## 2. UVA ( $T_{JMAX} = 85^{\circ}C$ )

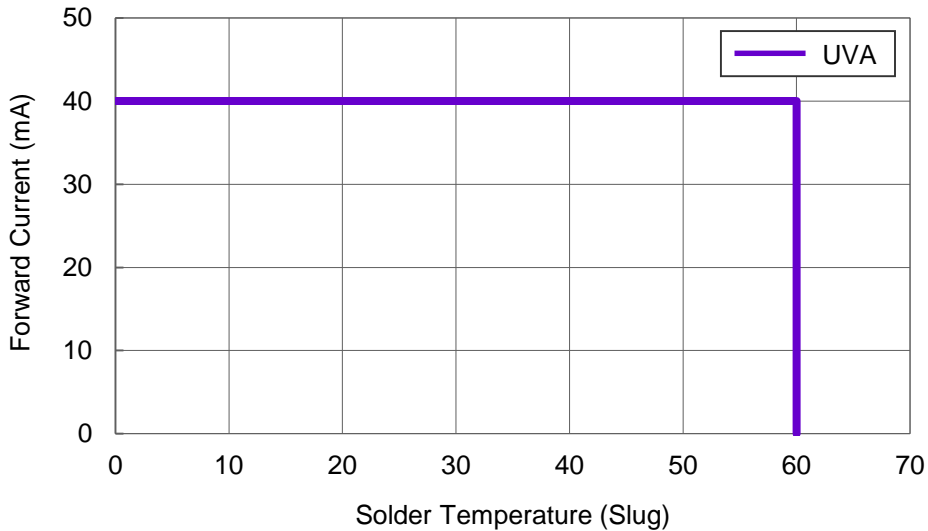

## Typical Representative Spatial Radiation Pattern

### Radiation Pattern

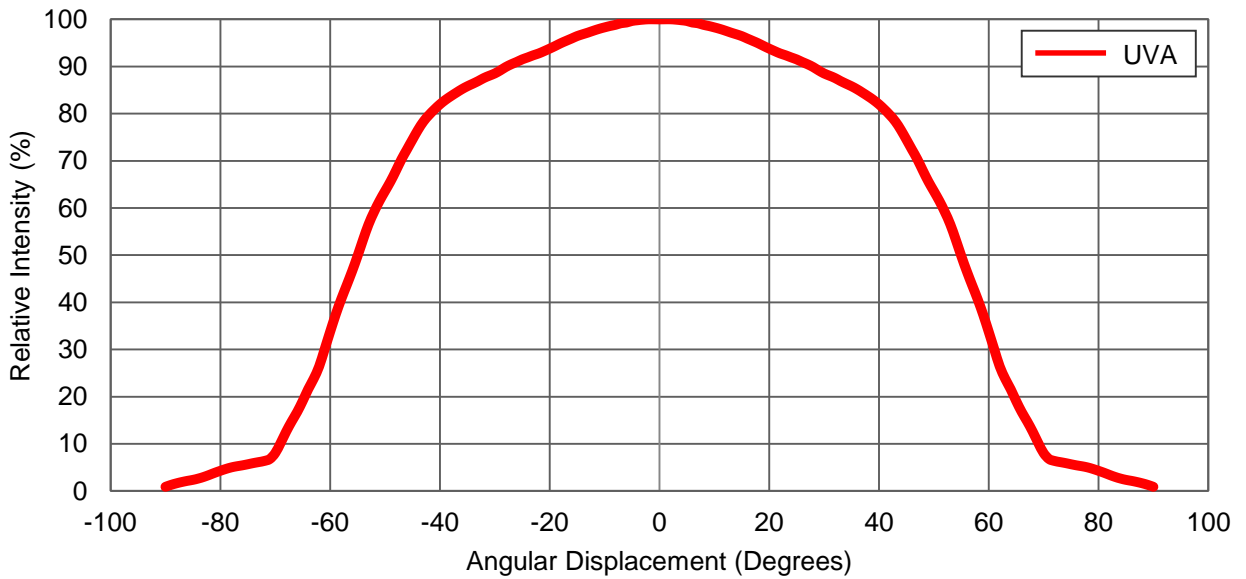
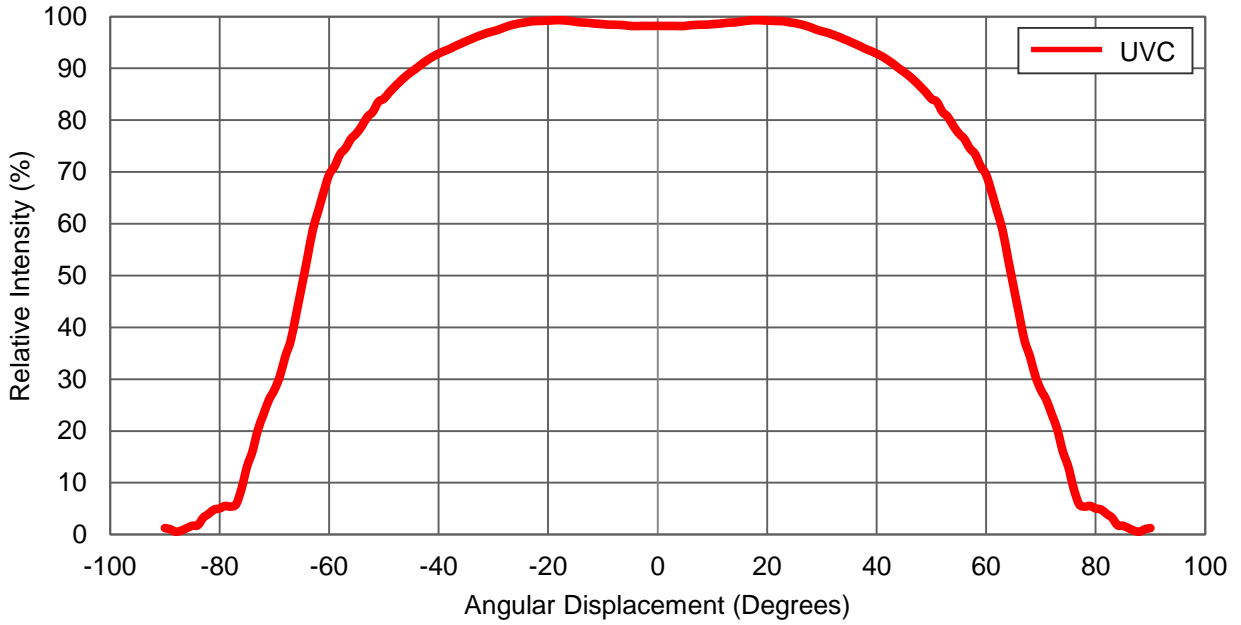

## During Storage

Conditions		Temperature	Humidity	Time
Storage	Before Opening Aluminum Bag	5°C ~ 30°C	< 50%RH	Within 1 Year from the Label Date Code
	After Opening Aluminum Bag	5°C ~ 30°C	< 60%RH	≤ 672 hours
Baking		65 ± 5°C	< 10%RH	10 ~ 24 hours

- The standard soak time includes a default value of 24 hours for semiconductor manufacture's exposure time (MET) between bake and bag and includes the maximum time allowed out of the bag at the distributor's facility.
- Table below presents the moisture sensitivity level definitions per IPC/JEDEC's J-STD-020D.

## Recommended Solder Pad Design

### Solder Pad

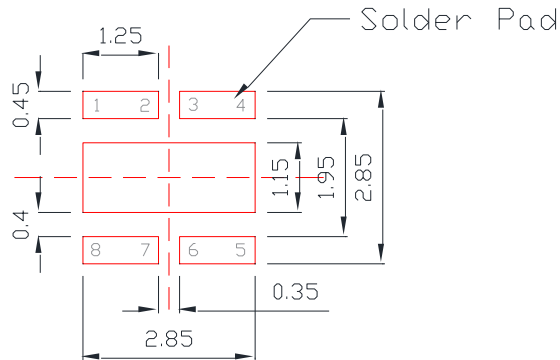

### Solder Resist

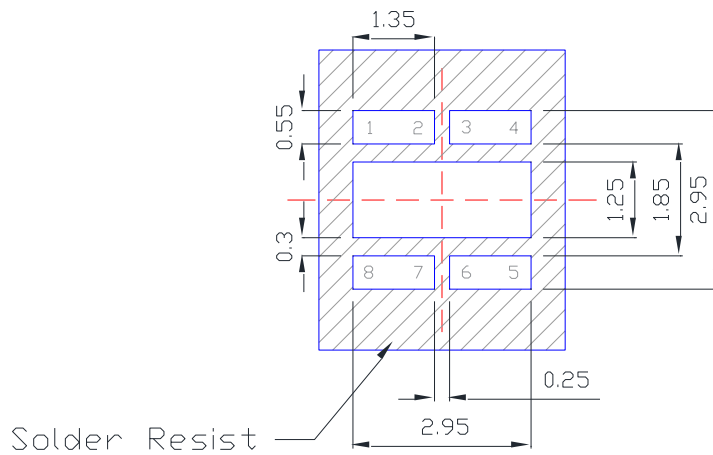

### Solder Stencil

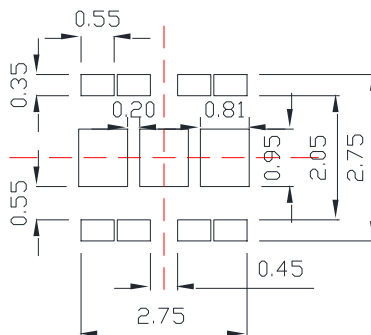

- All dimensions are in millimeters.
- Electrical isolation is required between Slug and Solder Pad.
- Recommended solder stencil thickness is 0.08mm

## Reflow Soldering Condition

Profile Feature	Sn-Pb Eutectic Assembly	Pb-Free Assembly
Average Ramp-Up Rate ( $T_{Smax}$ to $T_p$ )	3°C / second max.	3°C / second max.
Preheat <ul style="list-style-type: none"> <li>- Temperature Min (<math>T_{Smin}</math>)</li> <li>- Temperature Max (<math>T_{Smax}</math>)</li> <li>- Time (<math>t_{Smin}</math> to <math>t_{Smax}</math>)</li> </ul>	100°C 150°C 60-120 seconds	150°C 200°C 60-120 seconds
Time maintained above: <ul style="list-style-type: none"> <li>- Temperature (<math>T_L</math>)</li> <li>- Time (<math>t_L</math>)</li> </ul>	183°C 60-150 seconds	217°C 60-150 seconds
Peak/Classification Temperature ( $T_p$ )	235°C	250°C
Time Within 5°C of Actual Peak Temperature ( $t_p$ )	10-20 seconds	20-30 seconds
Ramp-Down Rate	6°C/second max.	6°C/second max.
Time 25°C to Peak Temperature	6 minutes max.	8 minutes max.

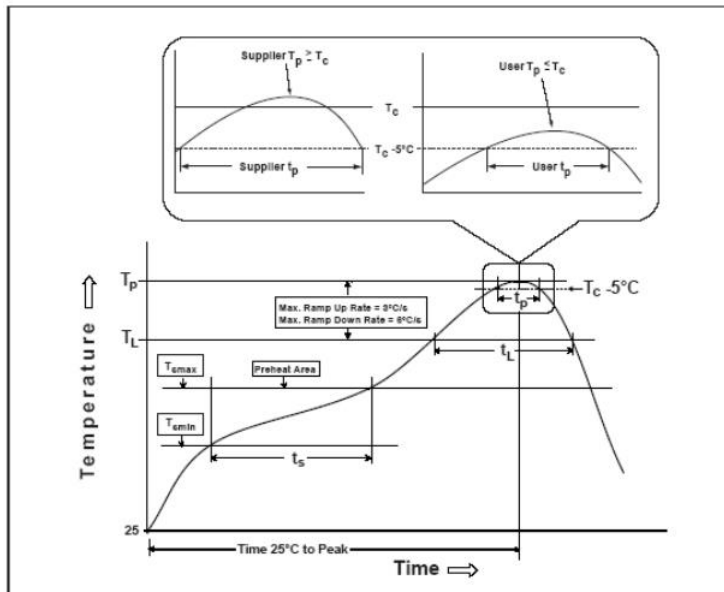

- We recommend using the M705-S101-S4 solder paste from SMIC (Senju Metal Industry Co., Ltd.) for lead-free soldering.
- Do not use solder pastes with post reflow flux residue > 47%. (58Bi-42Sn eutectic alloy, etc) This kind of solder pastes may cause a reliability problem to LED.
- All temperatures refer to topside of the package, measured on the package body surface.
- Repairing should not be done after the LEDs have been soldered. When repairing is unavoidable, a double-head soldering iron should be used. It should be confirmed beforehand whether the characteristics of the LEDs will or will not be damaged by repairing.
- Reflow soldering should not be done more than three times.
- When soldering, do not put stress on the LEDs during heating.
- After soldering, do not warp the circuit board.

## Emitter Reel Packaging

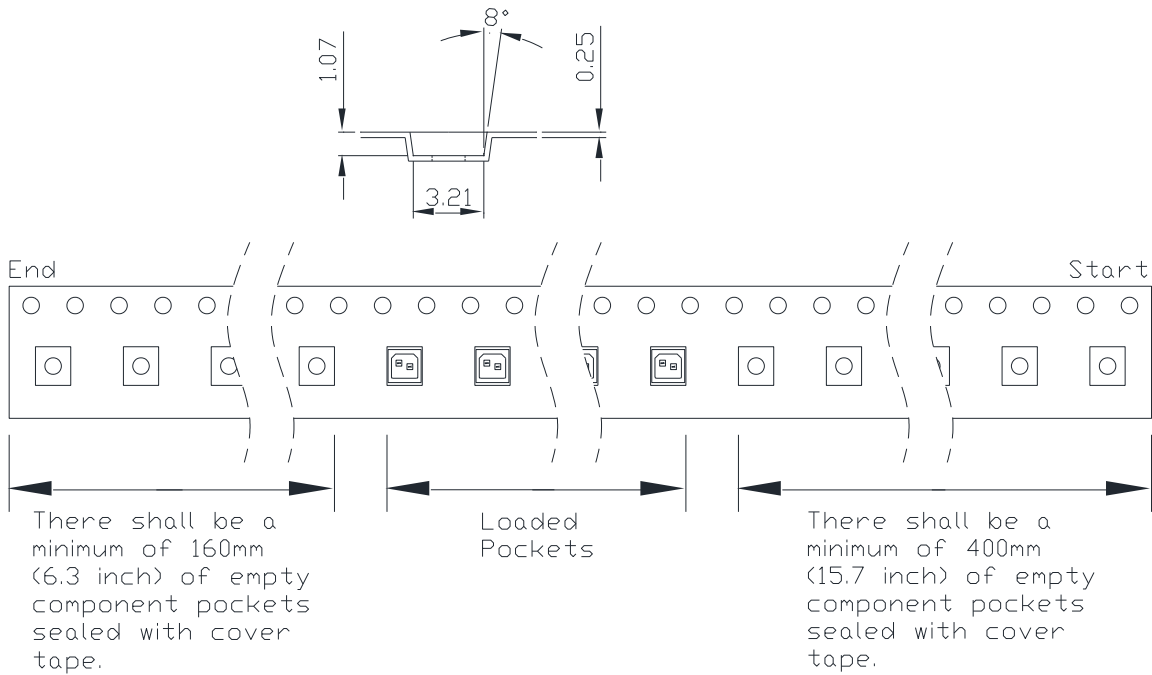
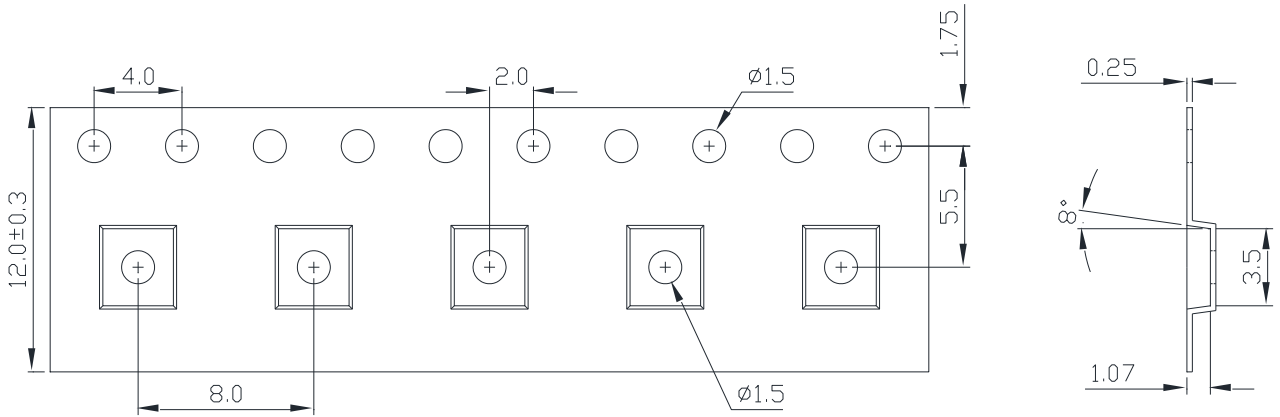

### Notes:

1. Drawing not to scale.
2. All dimensions are in millimeters.
3. Unless otherwise indicated, tolerances are  $\pm 0.10\text{mm}$ .

## Emitter Reel Packaging

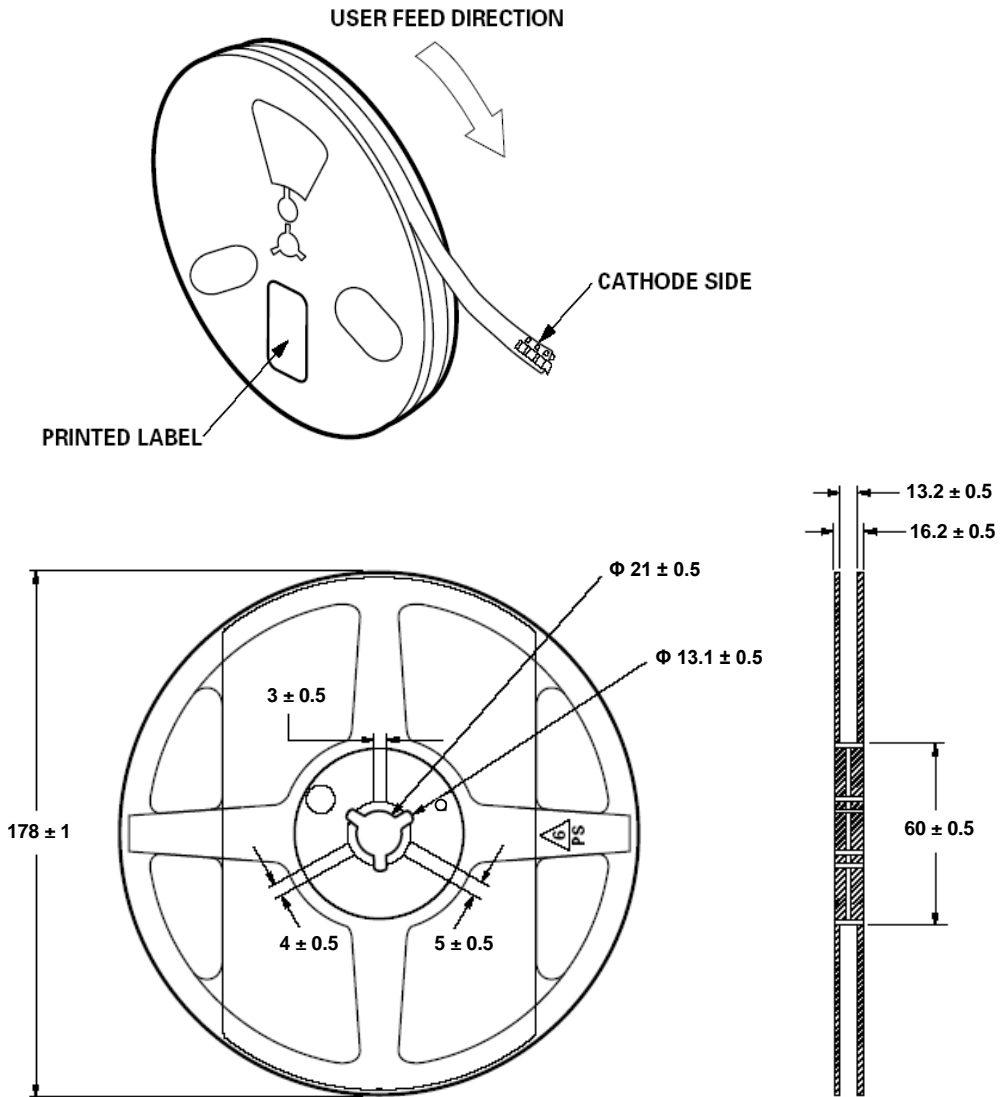

**Notes:**

1. Empty component pockets sealed with top cover tape.
2. 250 and 500 pieces per reel.
3. Drawing not to scale.
4. All dimensions are in millimeters.

## Precaution for Use

- Storage  
Please do not open the moisture barrier bag (MBB) more than one week. This may cause the leads of LED discoloration. We recommend storing ProLight's LEDs in a dry box after opening the MBB. The recommended storage conditions are temperature 5 to 30 °C and humidity less than 40% RH. It is also recommended to return the LEDs to the MBB and to reseal the MBB.
- LEDs are ESD (electrostatic discharge) sensitive; static electricity and surge voltages seriously damage UV LEDs and can result in product failure
  - (1) Ensure that tools, jigs and machines being used are properly grounded
  - (2) LED mounting equipment should include protection against voltage surge
  - (3) Use proper ESD protection, including grounded wrist straps, ESD footwear and clothes
- **We recommend using the M705-S101-S4 solder paste from SMIC (Senju Metal Industry Co., Ltd.) for lead-free soldering.**
- **Do not use solder pastes with post reflow flux residue >47%. (58Bi-42Sn eutectic alloy, etc) This kind of solder pastes may cause a reliability problem to LED.**
- Different products have different forward voltage and radiant power. In the circuit design, the distribution of current and voltage should be considered to avoid exceeding the maximum rated parameters of this product. In order to ensure the best use, it is recommended to assign a resistor in series to each emitter in the matrix circuit.

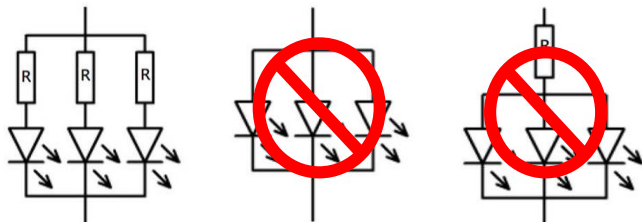

- Any mechanical force or any excess vibration shall not be accepted to apply during cooling process to normal temperature after soldering.
- Please avoid rapid cooling after soldering.
- Components should not be mounted on warped direction of PCB.
- Repairing should not be done after the LEDs have been soldered. When repairing is unavoidable, a heat plate should be used. It should be confirmed beforehand whether the characteristics of the LEDs will or will not be damaged by repairing.
- This device should not be used in any type of fluid such as water, oil, organic solvent and etc. When cleaning is required, isopropyl alcohol should be used.
- When the LEDs are illuminating, operating current should be decided after considering the package maximum temperature.
- The appearance, specifications and flux bin of the product may be modified for improvement without notice. Please refer to the below website for the latest datasheets.  
<http://www.prolightopto.com/>



## Eye Safety Guidelines

- During operation, the LED emits high intensity ultraviolet (UV) light, which is harmful to skin and eyes. UV light is hazardous to skin and may cause cancer. Avoid exposure to UV light when LED is operational. Precautions must be taken to avoid looking directly at the UV light without the use of UV light protective glasses. Do not look directly at the front of the LED or at the LED's lens when LED is operational.
- Attach warning labels on products/systems that use UV LEDs.

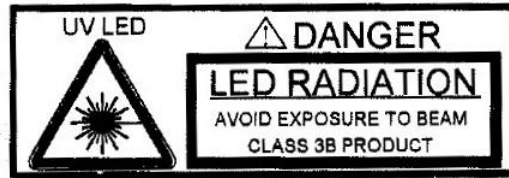

## Use Handling of LEDs

Notes for handling of LEDs

- The LEDs should only be picked up by making contact with the sides of the LED body.
- Avoid leaving fingerprints on the LEDs.
- Please store the LEDs away from dusty areas or seal the product against dust.
- When populating boards in SMT production, there are basically no restrictions regarding the form of the pick and place nozzle, except that mechanical pressure on the LEDs must be prevented.
- Please do not mold over the LEDs with another resin. (epoxy, urethane, etc)
- The UV LED is not protected by a lens and requires careful handling
  - (1) Do not handle the LED with bare hands as it may contaminate the LED surface and affect the optical characteristics.
  - (2) Avoid touching the LED die

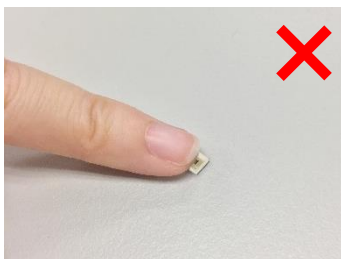

## DISCLAIMER

- The information in this document has been compiled from reference materials and other sources believed to be reliable, and given in good faith. No warranty, either expressed or implied, is made, however, to the accuracy and completeness of the information, nor is any responsibility assumed or implied for any loss or damage resulting from inaccuracies or omissions. Each user bears full responsibility for making their own determination as to the suitability of Prolight products, recommendations or advice for its own particular use. Prolight makes no warranty or guarantee, express or implied, as to results obtained in end-use, nor of any design incorporating its Products, recommendation or advice.
- Each user must identify and perform all tests and analyses necessary to ensure that its finished application incorporating Prolight products will be safe and suitable for use under end-use conditions. Each user of devices assumes full responsibility to become educated in and to protect from harmful irradiation. Prolight specifically disclaims any and all liability for harm arising from buyer's use or misuse of UV devices either in development or end-use.