

## RGBY FLEX LED STRIP

**FSHI.5050.R068.6024**  
**FSHI.5050.G068.6024**  
**FSHI.5050.B068.6024**  
**FSHI.5050.Y068.6024**







### TECHNICAL DETAILS

FSHI.5050.R068.6024 / FSHI.5050.G068.6024  
 FSHI.5050.B068.6024 / FSHI.5050.Y068.6024

<b>Product No.</b>	
<b>Power(W/M)</b>	<b>14.4</b>
<b>Voltage(V)</b>	<b>24</b>
<b>CRI</b>	<b>/</b>
<b>Led type</b>	<b>60</b>
<b>Length/Reel(M)</b>	<b>5</b>

### LUMENS PER METER

FSHI.5050.R068.6024 / FSHI.5050.G068.6024  
 FSHI.5050.B068.6024 / FSHI.5050.Y068.6024

<b>CCT</b>	
 <b>R620-625nm</b>	<b>220lm</b>
 <b>G520-530nm</b>	<b>520lm</b>
 <b>B450-470nm</b>	<b>150lm</b>
 <b>Y587-595nm</b>	<b>200lm</b>
 <b>/</b>	<b>/</b>

\* The given data are typical values. Due to tolerances of the production process and the electrical components, values for light output and electrical power can vary up to 10%.

## DIMENSION

### Jade series

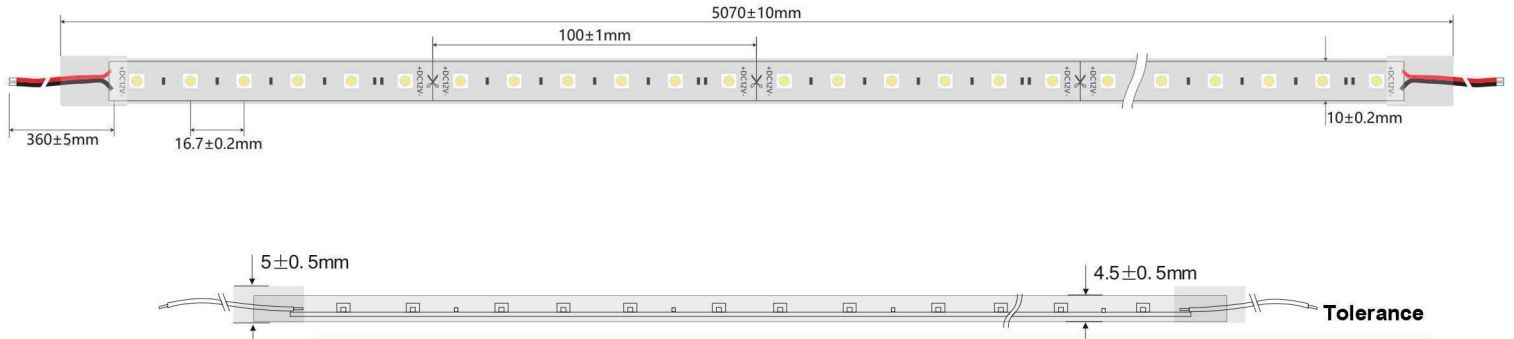

L1(mm)	5010	±10
L2(mm)	100	±1
L3(mm)	16.7	
L4(mm)	350	±0.2 ±5
W1(mm)	15	
H1(mm)	5	±0.1
		±0.1

## LIGHT DISTRIBUTION

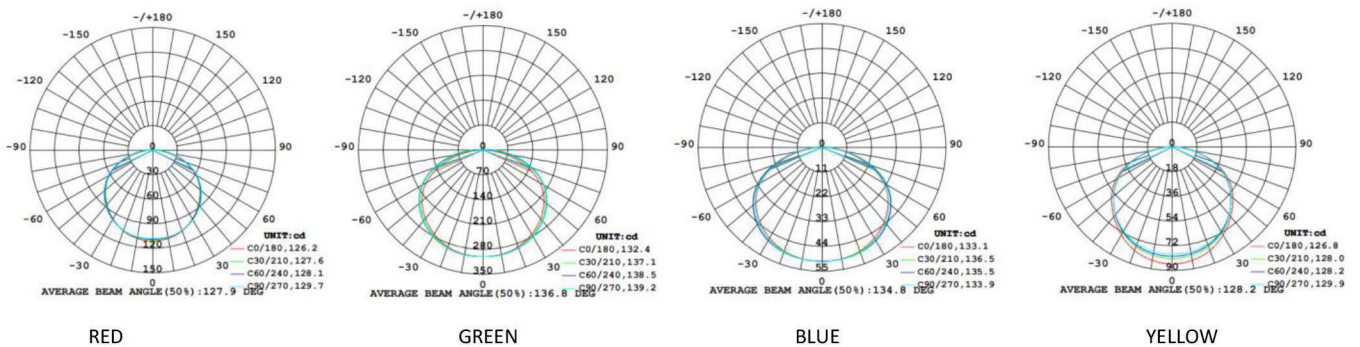

## WORKING CONDITIONS

Working Temperature (°C)	-25 ... 50
Storage Temperature(°C)	-30 ... 80
Voltage Range(V dc)	23 ... 25
Reverse Voltage(V dc)	25

\* Exceeding maximum ratings for operating and storage temperature will reduce expected life time or destroy the LED Modules.  
 \* Exceeding maximum ratings for operating voltage will cause hazardous overload and will likely destroy the LED Modules.

## SAFETY WARNING

- Install in accordance with nation I standards and local electrical codes.
- This product must be installed and maintained by a qualified electrician.
- Only install it with Class 2 DC constant voltage driver , Do not use this product if it does not comply with Class 2 standard.
- The power of drive must meet the output of the rated power, and do not exceed the specified output power.
- Use a cable with rated temperature at least 80 ° C and be certified for external connection of the electrical equipment.
- Improper electrical installation may cause the cable to overheat and cause a fire. Please use a suitable cable between the driver, the lamp, and the controller. When selecting a wire, the voltage and current must meet the rated values.
- The LED module itself and all its components must not be mechanically stressed.
- Assembly must not damage or destroy conducting paths on the circuit board.
- To avoid mechanical damage, the LED modules should be attached securely to the intended substrate. Heavy vibration should be avoided. Installation of LED modules (with power supplies) needs to be made with regard to all applicable electrical and safety standards. Only qualified personnel should be allowed to perform installation .
- Observe correct polarity! Incorrect polarity will lead to no light emission and may cause damage of the LED module..
- Parallel connection is highly recommended as safe electrical operation mode. Serial connection is not recommended. Unbalanced voltage drop can cause hazardous overload and damage the LED module.
- When mounting on metallic or otherwise conductive surfaces, there needs to be an electrical isolation at soldering points between module and the mounting surface.
- Pay attention to ESD steps when mounting the module.
- Please ensure that the power supply is of adequate power to operate the total load.
- Damage by corrosion will not be honored as a materials defect claim. It is the user's responsibility to provide suitable protection against corrosive agents such as moisture and condensation and other harmful elements.
- For application involving exposure to humidity and dust the module must be protected by a fixture or housing with a suitable protection class.

## PACKING

<b>End cap with hole(pc)</b>	485x380x260
<b>End cap without hole(pc)</b>	360x240x240
<b>Bracket(pc)</b>	/
<b>End cap glue(pc)</b>	/
<b>Glue tip mount (pc)</b>	/
<b>Screw(pc)</b>	15

